

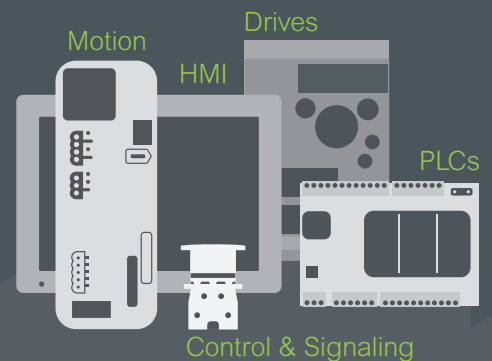

Introducing the **Easy Series**

Essential automation & control products

When just enough is just right!



Easy Altivar 310

Variable speed drives

For applications from 0.37 to 22 kW / 0.5 to 30 HP

General contents

Easy Altivar 310 variable speed drives

■ Variable speed drives	page 2
□ Presentation	page 2
□ Applications	page 2
□ Functions	page 2
□ An optimized offer	page 3
□ References	page 5
■ Configuration tools	page 6
□ Simple Loader and Multi-Loader	page 6
□ Remote display terminals	page 6
■ Options	page 7
□ Line chokes, motor chokes and LR filter cells	page 7
□ Braking resistors	page 8
□ Modbus serial link	page 8
■ Motor starters	page 9
■ Product reference index	page 10

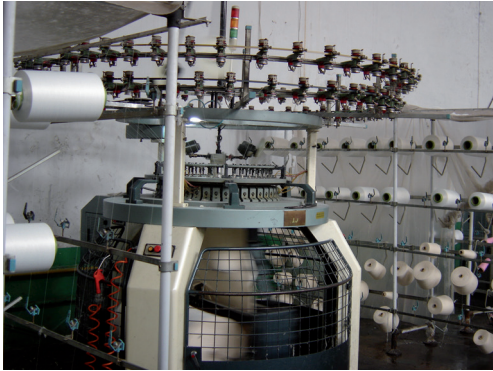

Textile machine



Packaging machine



Printing machine

Presentation

The Easy™ Altivar 310 drive is a frequency inverter for three-phase 380...460 V asynchronous motors rated from 0.37 kW/0.5 HP to 22 kW/30 HP.

The compact size of this drive, its robust design, its ease of installation, based on the principle of Plug & Play, its integrated functions and macro configuration make it particularly suitable for applications involving industrial machines and certain consumer machines.

By taking account of the constraints governing installation and use at the product design stage, we have been able to offer a reliable, cost-effective solution to manufacturers of compact machines (OEMs).

The Easy Altivar 310 has been developed with no compromise on quality : the components are designed to last 10 years.

Applications

The Easy Altivar 310 drive incorporates functions that are suitable for the most common applications, including:

- Textile machine
- Machine tools
- Wood making machine
- Material handling
- Packaging and printing machines
- Ceramic machine

Functions

In addition to the functions usually available on this type of drive, the Easy Altivar 310 drive also features the following:

Motor control functions (1)

- Motor control profiles: standard, performance and pump/fan
- Cooling fan thermal control
- Switching frequency management
- Boost torque
- Motor noise reduction
- Current limitation
- Auto DC injection

Application functions (1)

- Frequency skip
- Preset speeds
- PID regulator
- S ramp, U ramp, ramp switching
- Jog operation
- +/- speed around reference
- Freewheel stop, fast stop
- Automatic catching a spinning load with speed detection and automatic restart

Control functions (1)

- Channel configuration - separate mode or not
- Reference channel selection
- Reverse inhibition
- Force local control
- Store customer parameter settings

Protection and maintenance functions (1)

- Protection of the installation by means of underload and overload detection
- Maintenance functions:
 - HMI password
 - Configuring the logic and analog I/O
 - Configuring how the parameters are displayed
 - Viewing the state of the logic inputs on the drive display
 - Key parameters display (drive power on / Fan time / Process elapsed time)
 - The last 4 fault display, error log, etc.

(1) For the implementation of functions, please consult the user manual on our local website.



Easy Altivar 310 range

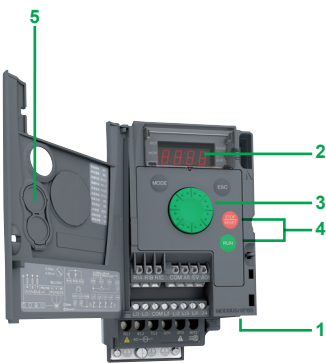

ATV310H037N4E with door on front panel open



Remote terminal with cover closed



Remote terminal with cover open: RUN, FWD/REV and STOP buttons accessible



Multi-Loader configuration tool

An optimized offer

Environment

The entire range conforms to international standards IEC/EN 61800-5-1 and IEC/EN 61800-3 and has been developed to meet the requirements of directives regarding the protection of the environment (RoHS, WEEE). Owing to its innovated air flow design and to its thicker coating which avoids polluting PCB, the range can be used in the harshest environments. It can withstand a 55 °C/131 °F ambient air temperature around the device without derating (1). Its degree of protection is IP 20 (IP 41 on top of the product).

Adaptability and performances

The Easy Altivar 310 has been designed with an increased adaptability to different motors and various tough loads.

One of its main quality is its torque capacity for starting and braking:

- Braking capacity:
 - over 80 % of the rated motor torque without braking resistor
 - 150 % of the rated motor torque with braking resistor (see page 60408/8)
- Torque capacity
 - starting torque 150 % at 3 Hz
 - over torque : 170 to 200 %, depending on model (2).

Easy to integrate in system

The Easy Altivar 310 drive integrates as standard the Modbus communication protocol, which can be accessed via the RJ45 connector located on the underside of the drive 1 with a 2-wire RS 485 physical interface. To communicate on the network, the Easy Altivar 310 speed drive uses the Modbus RTU transmission mode. For more information on the complementary characteristics of the Modbus port (transmission speed, address, messaging...), please consult our local website. Logic input can be configured as source or sink by software, compatible with many PLCs.

Easy to install

The Easy Altivar 310 drives can easily and quickly be installed as:

- they are easy and quick to wire due to their Plug & Play concept
- they can be identified on the front panel.
- they can be mounted side by side to save cabinet space.
- power terminal and connection labels are easily identified and differentiated
- a connection guideline is shown inside the front door.

Easy to commission

Human-Machine Interface (integrated keypad)

The 4-digit display 2 can be used to display states and faults, access parameters and modify them via the navigation button 3.

The RUN and STOP buttons 4 can be made accessible on the front panel by removing the blanking plate 5 from the door; they must be configured in order to be active.

Remote display terminal

The Easy Altivar 310 drive can be connected to a remote display terminal, available as an option. This terminal can be mounted on an enclosure door with IP 54 or IP 65 degree of protection. The maximum operating temperature is 50 °C/122 °F. It provides access to the same functions as the Human-Machine interface.

Simple Loader and Multi-Loader configuration tools

The Simple Loader tool enables one powered-up drive's configuration to be duplicated on another powered-up drive. Operation is very simple.

The Multi-Loader tool enables configurations from a PC or drive to be copied and duplicated on another drive; the drives do not need to be powered up. The configuration can be loaded onto the drive without taking it out of its packaging.

Easy to maintain

A warning is sent by the drive to the user when it is necessary to clean heat sink or replace cooling fan. This fan, which is the only wearing part, can be changed without the need for any tool.

The security of the system is ensured by an access code allowing authorized people to configure applications and settings in Configuration mode. Simple users are only allowed to use the Monitoring mode (parameters display).

(1) Detail temperature conditions and derating curves, please refer to User Manual.
 (2) For more information, please refer to our local website.

Main characteristics

Analog input AI1

1 software-configurable voltage or current analog input:

- Voltage analog input: 0...5 V $\overline{\text{---}}$ (internal power supply only) or 0...10 V $\overline{\text{---}}$, impedance 30 k Ω

- Analog current input: X-Y mA by programming X and Y from 0–20 mA, Impedance 250 Ω

Sampling time: < 20 ms

Resolution: 10 bits

Accuracy: $\pm 1\%$ at 25 °C/77 °F

Linearity: $\pm 0.3\%$ of the maximum scale value

Factory setting: Input configured as voltage type

Analog output AO1

1 software-configurable voltage or current analog output:

- Analog voltage output: 0...10 V $\overline{\text{---}}$, minimum load impedance 470 Ω

- Analog current output: 0–20 mA, maximum load impedance 800 Ω

Sampling time: < 10 ms

Resolution: 8 bits

Accuracy: $\pm 1\%$ at 25 °C/77 °F

Relay outputs R1A, R1B, R1C

1 protected relay output, 1 N/O contact and 1 N/C contact with common point

Response time: 30 ms maximum

Minimum switching capacity: 5 mA for 24 V $\overline{\text{---}}$

Maximum switching capacity:

- On resistive load ($\cos \varphi = 1$ and L/R = 0 ms): 3 A at 250 V \sim or 4 A at 30 V $\overline{\text{---}}$

- On inductive load ($\cos \varphi = 0.4$ and L/R = 7 ms): 2 A at 250 V \sim or 30 V $\overline{\text{---}}$

Logic inputs LI1...LI4

4 programmable logic inputs, compatible with PLC level 1, standard IEC/EN 61131-2 24 V $\overline{\text{---}}$ internal power supply or 24 V $\overline{\text{---}}$ external power supply (min. 18 V, max. 30 V)

Sampling time: < 20 ms

Sampling time tolerance: ± 1 ms

Factory-set with 2-wire control in "transition" mode for machine safety reasons:

- LI1: forward

- LI2...LI4: not assigned

Multiple assignment makes it possible to configure several functions on one input (for example: LI1 assigned to forward and preset speed 2, LI3 assigned to reverse and preset speed 3)

Impedance 3.5 k Ω

Logic outputs LO1

One 24 V $\overline{\text{---}}$ logic output assignable as positive logic (Source) or negative logic (Sink) open collector type, compatible with level 1 PLC, standard IEC/EN 61131-2

Maximum voltage: 30 V

Linearity: $\pm 1\%$

Maximum current: 10 mA (100 mA with external power supply)

Impedance: 1 k Ω

Update time: < 20 ms

Variable speed drives

Easy Altivar 310

Drives



ATV310H037N4E



ATV310HU15N4E



ATV310HU30N4E



ATV310HU75N4E



ATV310HD15N4E



ATV310HD22N4E

Drives										
Three-phase supply voltage: 380...460 V 50/60 Hz										
Motor	Line supply				Easy Altivar 310					
Power indicated on rating plate (1)	Max. line current (2)	Apparent power	Max. prospective line Isc	Maximum continuous output current (In) (1)	Maximum transient current for 60 s	Dissipated power at maximum output current (In) (1)	Reference (6)	Weight (3)		
HD: Heavy duty (4) ND: Normal duty (5)		380 V	460 V	460 V	380 V					
kW	HP	A	A	kVA	kA	A	A	W		kg/lb
HD 0.37	0.5	2.1	1.8	1.4	5	1.5	2.3	19.6	ATV310H037N4●	0.800/1.760
HD 0.75	1	3.5	3.1	2.5	5	2.3	3.5	28.8	ATV310H075N4●	0.800/1.760
HD 1.5	2	6.5	5.4	4.3	5	4.1	6.2	51.0	ATV310HU15N4●	1.100/2.430
HD 2.2	3	8.8	7.2	5.7	5	5.5	8.3	65.5	ATV310HU22N4●	1.100/2.430
HD 3	4	11.1	9.2	7.3	5	7.1	10.7	80.2	ATV310HU30N4●	1.800/3.970
ND 4	5	14.2	11.6	9.3	5	8.9	9.8	94.0		
HD 4	5	13.7	11.4	9.1	5	9.5	14.3	102.7	ATV310HU40N4●	1.800/3.970
ND 5.5	7.5	18.0	14.9	15.1	22	12.1	13.3	126.4		
HD 5.5	7.5	21.3	14.3	11.4	22	12.6	18.9	141.5	ATV310HU50N4●	1.800/3.970
ND 7.5	10	23.0	19.0	15.1	22	16.0	17.6	169.6		
HD 7.5	10	26.6	22.4	17.8	22	17	25.5	203.9	ATV310HU75N4●	3.700/8.160
ND 11	15	29.5	24.8	19.4	22	22.8	25.1	260.2		
HD 11	15	36.1	30.4	24.2	22	24	36	294.7	ATV310HD11N4●	3.700/8.160
ND 15	20	38.6	32.5	25.4	22	30	33	347.0		
HD 15	20	46.5	38.5	30.7	22	33	49.5	438.8	ATV310HD15N4●	6.300/13.900
ND 18.5	25	46.6	38.8	31.2	22	36	39.6	508.9		
HD 18.5	25	55.3	45.8	36.5	22	39	58.5	499.6	ATV310HD18N4●	6.300/13.900
ND 22	30	54.1	45.1	35.7	22	43	47.3	588.0		
HD 22	30	64.2	53.2	46.2	22	46	69	539.4	ATV310HD22N4●	8.500/18.700
ND 30	40	71.2	59.2	47	22	60	66	736.7		
HD 15	20	46.5	38.5	30.7	22	33	49.5	447.5	ATV310HD15N4●F	6.700/14.800
ND 18.5	25	46.6	38.8	31.2	22	36	39.6	517.6		
HD 18.5	25	55.3	45.8	36.5	22	39	58.5	511.9	ATV310HD18N4●F	6.700/14.800
ND 22	30	54.1	45.1	35.7	22	43	47.3	569.8		
HD 22	30	64.2	53.2	46.2	22	46	69	547.6	ATV310HD22N4●F	9.700/21.400
ND 30	40	71.2	59.2	47	22	60	66	746.8		

Dimensions (overall)		
Drives with heatsinks	W x H x D	
	mm	in.
ATV310H037N4●	72 x 143 x 130	2.83 x 5.63 x 5.12
ATV310H075N4●	72 x 143 x 140	2.83 x 5.63 x 5.51
ATV310HU15N4●, HU22N4●	105 x 143 x 151	4.13 x 5.63 x 5.94
ATV310HU30N4●...HU55N4●	140 x 184 x 151	5.51 x 7.24 x 5.94
ATV310HU75N4●, HD11N4●	150 x 232 x 171	5.91 x 9.13 x 6.73
ATV310HD15N4●, HD18N4●	180 x 330 x 191	7.09 x 12.99 x 7.52
ATV310HD22N4●	180 x 390 x 212	7.09 x 15.35 x 8.35

(1) These values are given for a nominal switching frequency of 4 kHz, for use in continuous operation. If operation above 4 kHz needs to be continuous, the nominal drive current should be derated by 10% for 8 kHz and 20% for 12 kHz.

The switching frequency can be set between 2 and 12 kHz for all ratings.

Above 4 kHz, the drive will reduce the switching frequency automatically in the event of an excessive temperature rise. See the derating curves in the User Manual, available on our local website.

(2) Typical value for the indicated motor power and for the maximum prospective line Isc.

(3) Weight of product without packaging.

(4) Values given for applications requiring significant overload (up to 150% for 60 s).

(5) Values given for applications requiring slight overload (up to 110% for 60 s).

(6) Easy Altivar ATV310●●●N4●F drives with integrated EMC filter category C3 with 25 m/82 ft shielded motor cable.

Configuration tools				
Description	For drives	Reference	Weight	kg/ lb
Simple Loader, Multi-Loader configuration tools and associated cable				
Simple Loader tool For duplicating one drive configuration on another drive. The drives must be powered-up. The tool is supplied with a cordset equipped with 2 RJ45 connectors.	ATV310H●●●N4●	VW3A8120		—
Multi-Loader tool 1 For copying a configuration on a PC or drive and duplicating it on another drive. The drives do not need to be powered-up. Supplied with the tool: <ul style="list-style-type: none"> ■ 1 cordset equipped with 2 RJ45 connectors ■ 1 cordset equipped with a USB type A connector and a USB Mini-B type connector ■ 1 x 2 GB SD memory card ■ 1 female/female RJ45 adaptor ■ 4 AA/LR6 1.5 V batteries 	ATV310H●●●N4●	VW3A8121		—
Cordset for Multi-Loader tool 2 For connecting the Multi-Loader tool to the Easy Altivar 310 drive in its packaging. Equipped with a non-locking RJ45 connector with special mechanical catch on the drive end and an RJ45 connector on the Multi-Loader end.	ATV310H●●●N4● in its packaging	VW3A8126		—

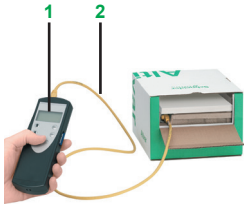

Configuring the drive in its packaging with the Multi-Loader tool VW3A8121+ cordset VW3A8126

Remote display terminals and associated cordsets				
Description	Degree of protection	For drives	Reference	Weight
Remote display terminals For fixing the Human-Machine interface on an enclosure door with IP 54 or IP 65 degree of protection. A remote-fixing cordset VW3A1104R●● is also required.	IP 54	ATV310H●●●N4●	VW3A1006	0.250/ 0.550
	IP 65	ATV310H●●●N4●	VW3A1007	0.275/ 0.610
Remote-fixing cordsets equipped with 2 RJ45 connectors. For connecting the VW3A1006 or VW3A1007 remote display terminal to the Easy Altivar 310 drive.	Length: 1 m/3.28 ft	ATV310H●●●N4●	VW3A1104R10	0.050/ 0.110
	Length: 3 m/9.84 ft	ATV310H●●●N4●	VW3A1104R30	0.150/ 0.330



VW3A1006 with cover open: RUN, FWD/REV and STOP buttons accessible

Dimensions (overall)				
Remote display terminal	W x H x D		Reference	Weight
	mm	in.		
VW3A1006	50 x 70 x 22.7	1.97 x 2.76 x 0.89		
VW3A1007	66 x 106 x 26.7	2.6 x 4.17 x 1.05		

Presentation

Line chokes

A line choke can be used to provide improved protection against overvoltages on the line supply and to reduce harmonic distortion of the current produced by the drive. They are recommended for ATV310...N4E drives. The recommended chokes limit the line current. They have been developed in line with standard EN 50178 (VDE 0160 level 1 high energy overvoltages on the line supply). The choke values are defined for a voltage drop between phases of between 3% and 5% of the nominal supply voltage. Values higher than this will cause loss of torque. These chokes should be installed upstream of the drive.

The use of line chokes is recommended in particular under the following circumstances:

- Close connection of several drives in parallel
- Line supply with significant disturbance from other equipment (interference, overvoltages)
- Line supply with voltage imbalance between phases above 1.8% of the nominal voltage
- Drive supplied by a line with very low impedance (in the vicinity of a power transformer 10 times more powerful than the drive rating)
- Installation of a large number of frequency inverters on the same line
- Reducing overloads on the cosφ correction capacitors, if the installation includes a power factor correction unit.

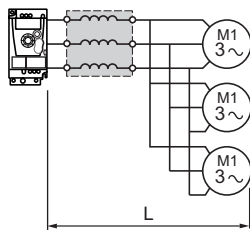

VW3A455
Motor choke

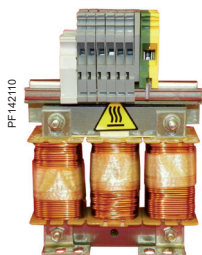

VW3A455

Presentation

Motor chokes and LR filter cell

Motor chokes are required:

- When connecting more than 2 motors in parallel
- When the motor cable length (L), including tap-offs, is:
 - 25 m/82.2 ft maximum for a shielded motor cable (1),
 - 50 m/164.4 ft maximum for an unshielded motor cable (1).

LR filter cell comprises 3 high-frequency chokes and 3 resistors.

References

Line chokes

For drives

	Duty	Line current without choke		Line current with choke		Choke Reference	Weight
		380 V	460 V	380 V	460 V		
		A	A	A	A		
ATV310H037N4●	HD	2.1	1.8	1.1	1	VW3A4551	1.500/ 3.310
ATV310H075N4●	HD	3.5	3.1	1.9	1.7		
ATV310HU15N4●	HD	6.5	5.4	3.5	2.9	VW3A4552	3.700/ 8.160
ATV310HU22N4●	HD	8.8	7.2	5.1	4.4		
ATV310HU30N4●	HD	11.1	9.2	6.6	5.6	VW3A4552	3.700/ 8.160
	ND	14.2	11.6	8.5	7.1		
ATV310HU40N4●	HD	13.7	11.4	8.5	7.7	VW3A4553	4.100/ 9.040
	ND	18	14.9	11.6	9.9		
ATV310HU50N4●	HD	21.3	14.3	11.6	9.9	VW3A4553	4.100/ 9.040
	ND	23	19	15.3	12.8		
ATV310HU75N4●	HD	26.6	22.4	16.1	14.2	VW3A4554	6.150/ 13.230
	ND	29.5	24.8	22.2	18.8		
ATV310HD11N4●	HD	36.1	30.4	22	18.3	VW3A4554	6.150/ 13.230
	ND	38.6	32.5	29.9	25		
ATV310HD15N4●	HD	46.5	38.5	28.9	24.4	VW3A4554	6.000/ 13.228
	ND	46.6	38.8	29	29		
ATV310HD18N4●	HD	55.3	45.8	36.4	31.6	VW3A4555	11.000/ 24.251
	ND	54.1	45.1	41.8	35.3		
ATV310HD22N4●	HD	64.2	53.2	42.4	36.3	VW3A4555	11.000/ 24.251
	ND	71.2	59.2	57.2	48.3	VW3A4556	16.000/ 35.270
ATV310HD15N4●F	HD	46.5	38.5	28.9	24.4	VW3A4554	6.000/ 13.228
	ND	46.6	38.8	29	29		
ATV310HD18N4●F	HD	55.3	45.8	36.4	31.6	VW3A4555	11.000/ 24.251
	ND	54.1	45.1	41.8	35.3		
ATV310HD22N4●F	HD	64.2	53.2	42.4	36.3	VW3A4555	11.000/ 24.251
	ND	71.2	59.2	57.2	48.3	VW3A4556	16.000/ 35.270

Motor chokes and LR filter cell

For drives

	Losses W	Nominal current A	Reference	Weight kg/lb
ATV310H037N4●...HU15N4●	150	10	VW3A58451 (2)	7.400/ 16.310
ATV310HU22N4●...HU40N4●	65	10	VW3A4552	3.700/ 8.160
ATV310HU55N4●	75	16	VW3A4553	4.100/ 9.040
ATV310HU75N4●...HD11N4●	90	30	VW3A4554	6.150/ 13.230
ATV310HD15N4●	430	215	VW3A5104 (3)	15.500/ 34.172
ATV310HD18N4●	430	215		
ATV310HD22N4●	430	215		

Dimensions (overall)

Line chokes or motor chokes, W x H x D

LR filter cell

	mm	in.
VW3A4551	100 x 135 x 60	3.94 x 5.31 x 2.36
VW3A4552, VW3A4553	130 x 155 x 90	5.12 x 6.1 x 3.54
VW3A4554	155 x 170 x 135	6.1 x 6.69 x 5.31
VW3A4555	180 x 210 x 160	7.1 x 8.27 x 6.30
VW3A4556	270 x 210 x 180	10.63 x 8.27 x 7.09
VW3A58451	169.5 x 340 x 123	6.67 x 1.39 x 4.48
VW3A5104	170 x 250 x 100	6.69 x 9.84 x 3.94

(1) Motor cable length given for a switching frequency of 4 kHz.

(2) LR filter cell

(3) With this option, drive can be used for 200 m with a shielded motor cable/300 m with an unshielded motor cable



VW3A7701

Braking resistors						
For drives	Minimum Ohmic value	Ohmic value at		Power available at	Reference	Weight
		20° C/68 °F	50° C/122 °F (1)			
	Ω	Ω	W			kg/lb
Not protected resistor (IP00) (2)						
ATV310HU15N4●	80	100	28	VW3A7723		0.600/1.320
ATV310HU22N4●	60					
ATV310HU30N4●	36	100	35	VW3A7725		0.850/1.870
ATV310HU40N4●	36					
Protected resistor (IP20 or 23)						
ATV310HU15N4●	80	100	100	VW3A7730		1.500/3.306
ATV310HU22N4●	60					
ATV310HU30N4●	36					
ATV310HU40N4●	36					
ATV310HU55N4●	28	60	160	VW3A7731		2.000/4.409
ATV310HU75N4●	28					
ATV310HD11N4●	28	28	300	VW3A7732		3.000/6.613
ATV310HD15N4●	16	16	960	VW3A7733		4.000/8.818
ATV310HD18N4●	10	16	960			
ATV310HD22N4●	10	16	960			
ATV310HD15N4●F	16	16	960			
ATV310HD18N4●F	10	16	960			
ATV310HD22N4●F	10	16	960			

Dimensions (overall)		
Braking resistors	W x H x D	
	mm	in.
VW3A7723	60 x 170 x 30	2.36 x 6.659 x 1.18
VW3A7725	62 x 212 x 36	2.44 x 8.35 x 1.42
VW3A7730	105 x 295 x 100	4.13 x 11.61 x 3.94
VW3A7731	105 x 345 x 100	4.13 x 13.58 x 3.94
VW3A7732	175 x 345 x 100	6.89 x 13.58 x 3.94
VW3A7733	190 x 570 x 180	7.48 x 22.44 x 7.09

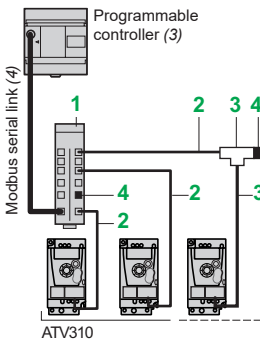

Example of Modbus diagram with connection via splitter box and RJ45 connectors

Modbus serial link					
Description	Item no.	Length m/ft	Unit reference	Weight kg/lb	
Connection via splitter box and RJ45 connectors					
Modbus splitter box 10 RJ45 connectors and 1 screw terminal		–	LU9GC3	0.500/1.100	
Cordsets for Modbus serial link equipped with 2 RJ45 connectors	2	0.3/0.98	VW3A8306R03	0.025/0.060	
		1/3.28	VW3A8306R10	0.060/0.060	
		3/9.84	VW3A8306R30	0.130/0.290	
Modbus T-junction boxes (with integrated cable)	3	0.3/0.98	VW3A8306TF03	0.190/0.420	
		1/3.28	VW3A8306TF10	0.210/0.460	
Line terminators (5) (6) For RJ45 connector	R = 120 Ω C = 1 nf	4	–	VW3A8306RC	0.010/0.020
	R = 150 Ω	4	–	VW3A8306R	0.010/0.020

(1) Load factor for resistors: the value of the average power that can be dissipated at 50 °C from the resistor into the casing is determined for a load factor during braking that corresponds to the majority of normal applications.

(2) For not protected resistors, add a thermal overload device.

(3) Please refer to the programmable controller catalogue on our local website.

(4) Cable depends on the type of controller or PLC.

(5) Order in multiples of 2.

(6) Depends on the bus architecture.

Applications

The proposed combinations can:

- Protect people and equipment (when a short-circuit occurs)
- Maintain protection upstream of the drive in the event of a short-circuit on the power stage

Two types of combination are possible:

- Drive + circuit-breaker: Minimum combination
- Drive + circuit-breaker + contactor: Minimum combination with contactor when a control circuit is needed

Motor starters

Three-phase supply voltage: 380...460 V 50/60 Hz

Standard power ratings of three-phase 4-pole 50/60 Hz motors (2)	Variable speed drive	Combination with control circuit			
		Minimum combination (circuit-breaker only)		TeSys contactor (1)	
kW	HP	TeSys motor circuit-breaker (3)	Operating range or rating		
		A			
M1	A1	Q1		KM1	
0.37	0.5	ATV310H037N4●	GZ1N08N	2.5	LC1N06
0.75	1	ATV310H075N4●	GZ1N08N	4	LC1N06
1.5	2	ATV310HU15N4●	GZ1N14N	10	LC1N09
2.2	3	ATV310HU22N4●	GZ1N14N	10	LC1N09
3	4	ATV310HU30N4●	GZ1N16N	14	LC1N12
4	5.4	ATV310HU40N4●	GZ1N16N	14	LC1N18
5.5	7.4	ATV310HU55N4●	GZ1N22N	25	LC1N25
7.5	10	ATV310HU75N4●	GZ1N32N	32	LC1N32
11	15	ATV310HD11N4●	CVS100F350	40	LC1N38
15	20	ATV310HD15N4●	CVS100F350	50	LC1N50
18.5	25	ATV310HD18N4●	CVS100F363	60	LC1N65
22	30	ATV310HD22N4●	CVS100F380	80	LC1N80

(1) For a complete list of references for TeSys contactors, please visit our local website.

(2) Motor power indicated for combination with an ATV310H●●●N4E drive with the same rating.

(3) TeSys motor circuit-breakers:

- GZ1N●●: Thermal magnetic motor circuit-breakers with pushbutton control
- CVS●●: Molded-case circuit breakers with adjustable setting.

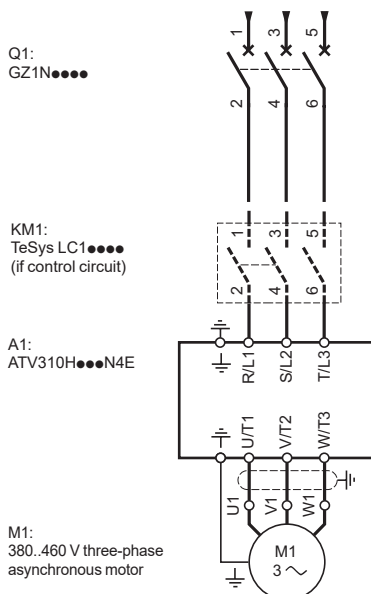

Motor starter with three-phase power supply

A	
ATV310H037N4●	5
ATV310H075N4●	5
ATV310HD11N4●	5
ATV310HD15N4●	5
ATV310HD15N4●F	5
ATV310HD18N4●	5
ATV310HD18N4●F	5
ATV310HD22N4●	5
ATV310HD22N4●F	5
ATV310HU15N4●	5
ATV310HU22N4●	5
ATV310HU30N4●	5
ATV310HU40N4●	5
ATV310HU50N4●	5
ATV310HU75N4●	5
L	
LU9GC3	8
V	
VW3A1006	6
VW3A1007	6
VW3A1104R10	6
VW3A1104R30	6
VW3A4551	7
VW3A4552	7
VW3A4553	7
VW3A4554	7
VW3A4555	7
VW3A4556	7
VW3A5104	7
VW3A58451	7
VW3A7723	8
VW3A7725	8
VW3A7730	8
VW3A7731	8
VW3A7732	8
VW3A7733	8
VW3A8120	6
VW3A8121	6
VW3A8126	6
VW3A8306R	8
VW3A8306R03	8
VW3A8306R10	8
VW3A8306R30	8
VW3A8306RC	8
VW3A8306TF03	8
VW3A8306TF10	8

Life Is On



Learn more about our products at
www.schneider-electric.com

The information provided in this documentation contains general descriptions and/or technical characteristics of the performance of the products contained herein. This documentation is not intended as a substitute for and is not to be used for determining suitability or reliability of these products for specific user applications. It is the duty of any such user or integrator to perform the appropriate and complete risk analysis, evaluation and testing of the products with respect to the relevant specific application or use thereof. Neither Schneider Electric nor any of its affiliates or subsidiaries shall be responsible or liable for misuse of the information contained herein.

Design: Schneider Electric
Photos: Schneider Electric

Schneider Electric Industries SAS

Head Office
35, rue Joseph Monier - CS 30323
F-92500 Rueil-Malmaison Cedex
France

DIA2ED2140701EN
February 2021 - V3.0